

温度保险丝  
Thermal-Link (ATCO)



ATCO

ATCO

特征 Features

- |                         |  |
|-------------------------|--|
| ● 断开温度精确                | High Accuracy of Functioning Temp.     |
| ● 一次性过温保护               | Non-Resettable over Temp. Protection   |
| ● 密封结构                  | Sealed Construction                    |
| ● 低阻抗                   | Low Impedance                          |
| ● 额定电流: (1 ~ 200) A     | Rated Current: (1 ~ 200) A             |
| ● 额定动作温度: (76 ~ 230) °C | Rated Functioning Temp.: (76 ~ 230) °C |
| ● 符合RoHS & REACH        | RoHS & Reach Compliant                 |



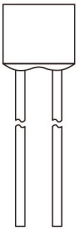
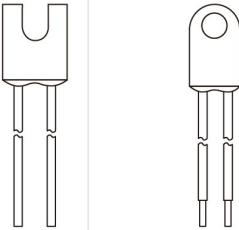
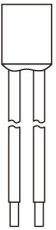
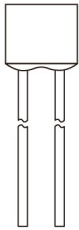

温度保险丝特性与型号概览  
Thermal-Link (ATCO) Feature & Model List Overview

额定动作温度 Rated Functioning Temp. $T_r$ (°C)	127	132	137	142	147	152	14	19	33	47	56	68	89	93	80	86	24	38	105	115	*	109	119	123	29	43	页码 Page	
	230	○	○	○	○	○	○	○	○	○	○	○	○	○	○	○	○	○	○	○	○	SKL230	SE230	○	○	○	○	○
221	V31	H31	B31	C31	U31	R31	○	K31	X31	○	○	○	○	○	○	○	KG31	XG31	SK221	○	○	TK221	○	○	○	○	○	
205	V32	H32	B32	C32	U32	R32	○	K32	X32	○	○	○	○	○	○	○	KG32	XG32	SK205	○	○	TK205	○	○	○	○	○	
200	○	○	○	○	○	○	○	○	○	○	○	○	○	○	○	○	○	○	○	○	SKL200	SE200	○	○	○	○	○	
187	○	○	○	○	○	○	○	K17	X17	○	○	○	○	○	○	○	○	○	○	○	○	○	○	○	○	○		
160	V16	H16	B16	C16	U16	R16	F16	K16	X16	Y16	○	○	○	○	○	○	KG16	XG16	SK160	○	○	TK160	○	○	○	○		
150	V7	H7	B7	C7	U7	R7	F7	K7	X7	Y7	S150	T150	○	○	N150	G150	KG7	XG7	SK150	○	○	TK150	○	○	KM7	XM7		
145	V6	H6	B6	C6	U6	R6	F6	K6	X6	Y6	○	○	○	○	○	○	KG6	XG6	SK145	○	○	TK145	SY145	TY145	○	○		
139	V13	H13	B13	C13	○	○	○	○	○	○	○	○	○	○	○	○	○	○	○	○	○	○	○	○	○	○	○	
136	V9	H9	B9	C9	○	○	○	K9	X9	Y9	S136	T136	P136	Q136	N136	G136	KG9	XG9	○	○	○	○	○	○	○	○		
135	V5	H5	B5	C5	U5	R5	○	K5	X5	○	○	○	○	○	○	○	KG5	XG5	SK135	○	○	TK135	○	○	KM5	XM5		
133	V8	H8	B8	C8	○	○	F8	K8	X8	Y8	○	○	○	○	○	○	KG8	XG8	○	○	○	○	○	○	○	○		
130	V4	H4	B4	C4	U4	R4	F4	K4	X4	Y4	○	○	○	○	N130	G130	KG4	XG4	SK130	○	○	TK130	SY130	TY130	KM4	XM4		
125	V3	H3	B3	C3	U3	R3	F3	K3	X3	Y3	S125	T125	○	○	N125	G125	KG3	XG3	SK125	○	○	TK125	SY125	TY125	○	○		
123	○	○	○	○	○	○	○	○	○	○	○	○	○	○	○	○	○	○	○	○	○	○	○	○	○	○	○	
120	○	○	○	○	○	○	○	○	○	○	○	○	○	○	○	○	○	○	○	○	○	○	○	○	○	○	○	
115	V2	H2	B2	C2	U2	R2	F2	K2	X2	Y2	S115	T115	P115	Q115	N115	G115	KG2	XG2	SK115	○	○	TK115	SY115	TY115	○	○		
105	○	○	○	○	○	○	○	○	○	○	○	○	○	○	○	○	○	○	○	○	○	○	○	○	○	○	○	
102	V1	H1	B1	C1	U1	R1	F1	K1	X1	Y1	S102	T102	○	○	N102	G102	KG1	XG1	SK102	○	○	TK102	○	○	○	○		
97	V21	H21	B21	C21	○	○	○	○	○	○	○	○	○	○	○	○	○	○	○	○	○	○	○	○	○	○	○	
95	○	○	○	○	○	○	○	○	○	○	○	○	○	○	○	○	○	○	○	○	○	○	○	○	○	○	○	
86	V18	H18	B18	C18	U18	R18	F18	K18	X18	Y18	○	○	○	○	○	○	KG18	XG18	○	○	○	○	○	○	○	○		
76	V0	H0	B0	C0	U0	R0	F0	K0	X0	Y0	○	○	○	○	○	○	KG0	XG0	○	○	○	○	○	○	○	○		
$I_F$ (A) 额定电流 Rated Current	1	2	3	5	10	15	1	2	3	5	10	15 16	20	25	30	40	2	3	10	10	10	15 16	10	15	2	3		
$U_F$ (VAC) 额定电压 Rated Voltage	250																							300				
产品结构 Product Structure																												
	轴向型 Axial Shape					径向型 Radial Shape											径向型 (带螺丝孔) Radial Shape (Screw Hole)				圆柱型 Cylindrical		径向型 Radial Shape					

备注 Note:

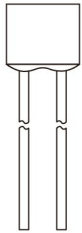
\* : 表示产品还在开发中。 Indicates that the product is under development .

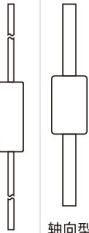
温度保险丝特性与型号概览  
Thermal-Link (ATCO) Feature & Model List Overview

额定动作温度 Rated Functioning Temp. $T_f$ (°C)	页码 Page																				型号 Model							
	47	52	60	72	93	89	93	*	*	169	173	*	*	*	*	127	132	137	142	142		127	132	127	137	157		
230	○	○	○	○	○	○	○	○	○	○	○	○	○	○	○	○	○	○	○	○	○	○	○	○	○	○		
221	○	○	○	○	○	○	○	○	○	○	○	○	○	○	○	○	○	○	○	○	○	V31	H31	○	B31	○		
205	○	○	○	○	○	○	○	○	○	○	○	○	○	○	○	○	○	○	○	○	○	V32	H32	○	B32	○		
200	○	○	○	○	○	○	○	○	○	○	○	○	○	○	○	○	○	○	○	○	○	○	○	○	○	○		
160	○	○	○	○	○	○	○	○	○	○	○	○	○	○	○	○	○	○	○	○	○	V16	H16	○	B16	○		
150	Y7	YM7	SM150	TM150	○	○	○	HU7	HR7	○	○	HC7	○	HL7	HW7	V7	H7	B7	○	C7	○	○	○	○	○	○		
145	○	○	○	○	○	○	○	HU6	HR6	HS145	HP145	HC6	HN145	HL6	HW6	V6	H6	B6	○	C6	○	○	○	○	○	○		
139	○	○	○	○	○	○	○	○	○	○	○	○	○	○	○	V13	H13	B13	○	C13	○	○	○	○	○	○		
136	Y9	YM9	SM136	TM136	Q136	P136	Q136	○	○	HS136	HP136	○	HN136	○	○	V9	H9	B9	○	C9	○	○	○	○	○	○		
135	○	○	○	○	○	○	○	HU5	HR5	○	○	HC5	○	HL5	HW5	V5	H5	B5	○	C5	○	○	○	○	○	○		
133	○	○	○	○	○	○	○	○	○	○	○	○	○	○	○	V8	H8	B8	○	C8	○	○	○	○	○	SF8		
130	Y4	YM4	○	○	○	○	○	HU4	HR4	○	○	○	○	HL4	HW4	V4	H4	B4	○	C4	○	○	○	○	○	SF4		
125	○	○	○	○	○	P125	Q125	HU3	HR3	HS125	HP125	HC3	HN125	HL3	HW3	V3	○	B3	○	C3	○	H3	○	○	○	○		
123	○	○	○	○	○	○	○	○	○	○	○	○	○	○	○	○	○	○	○	○	○	○	○	○	○	○		
120	○	○	○	○	○	○	○	○	○	○	○	○	○	○	○	○	○	○	○	○	○	○	○	○	○	○		
115	○	○	SM115	TM115	Q115	P115	Q115	HU2	HR2	○	○	HC2	○	HL2	HW2	V2	H2	B2	○	C2	○	○	○	○	○	SF2		
105	○	○	○	○	○	○	○	○	○	○	○	○	○	○	○	○	○	○	○	○	○	○	○	○	○	○		
102	○	○	SM102	TM102	○	P102	Q102	HU1	HR1	○	○	HC1	○	HL1	HW1	V1	H1	B1	C1	○	○	○	○	○	○	○		
97	○	○	○	○	○	○	○	○	○	○	○	○	○	○	○	V21	H21	B21	C21	○	○	○	○	○	○	○		
95	○	○	○	○	○	○	○	○	○	○	○	○	○	○	○	○	○	○	○	○	○	○	○	○	○	○		
86	○	○	○	○	○	○	○	HU18	HR18	○	○	HC18	○	HL18	HW18	V18	H18	B18	C18	○	○	○	○	V18	○	○		
76	○	○	○	○	○	○	○	HU0	HR0	○	○	HC0	○	HL0	HW0	V0	H0	B0	C0	○	○	○	○	○	○	○		
$I_f$ (A) 额定电流 Rated Current	5	5	10	15 16	25	20	25	10	15	5	10	5	15	10	15	1	2	3	5	7	1	2	2.5	3	3			
$U_f$ (VAC) (VDC) 额定电压 Rated Voltage	300 (VAC)				400 (VAC)				500 (VAC)				690 (VAC)				800 (VAC)				50 (VDC)				60 (VDC)			
产品结构 Product Structure																												
	径向型 Radial Shape				轴向型 Axial Shape				轴向型 (扁电极) Axial Shape (Flat Electrode)				轴向型 (扁电极) Axial Shape (Flat Electrode)				轴向型 Axial Shape				轴向型 Axial Shape							

备注 Note:

\* : 表示产品还在开发中。 Indicates that the product is under development .

温度保险丝特性与型号概览  
Thermal-Link (ATCO) Feature & Model List Overview

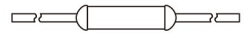
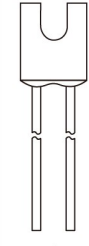
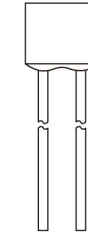
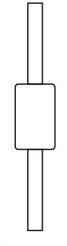
额定动作温度 Rated Functioning Temp. $T_f$ (°C)	157 127 142 142 142 142 161 142 147 152 165 24 38 19 33 14 33 89 93 64 76 97 101 169 173 177															页码 Page																																									
																型号 Model																																									
230	○	○	○	○	○	○	○	○	○	○	○	○	○	○	○	○	○	○	○	○	○	○	○	○	○	○	○	○																													
221	○	○	C31	○	○	○	○	○	U31	R31	○	○	○	○	○	○	○	○	○	○	○	○	○	○	○	○	○	○																													
205	○	○	C32	○	○	○	○	○	U32	R32	○	○	○	○	○	○	○	○	○	○	○	○	○	○	○	○	○	○																													
200	○	○	○	○	○	○	○	○	○	○	○	○	○	○	○	○	○	○	○	○	○	○	○	○	○	○	○	○																													
160	○	○	C16	○	○	○	○	○	U16	R16	○	○	○	○	○	○	○	○	○	○	○	○	○	○	○	○	○	○																													
150	○	○	○	○	○	○	○	○	U7	R7	○	○	○	○	○	○	○	○	○	○	SD150	TD150	PD150	QD150	HS150	HP150	HN150																														
145	○	○	○	○	○	○	○	C6	U6	R6	○	○	○	○	○	○	F6	X6	○	○	○	○	○	○	○	○	○	○																													
139	SF13	V13	○	○	○	○	C13	M13	○	○	○	○	○	○	○	○	○	○	○	○	○	○	○	○	○	○	○	○																													
136	○	○	○	○	○	○	○	○	○	○	○	○	○	○	○	○	○	○	X9	P136	Q136	SD136	TD136	PD136	QD136	HS136	HP136	HN136																													
135	○	○	○	○	○	○	○	○	U5	R5	○	○	○	○	○	○	○	○	○	○	○	○	○	○	○	○	○	○																													
133	○	V8	○	○	○	○	○	○	○	○	○	○	○	○	○	○	○	F8	○	○	○	○	○	○	○	○	○	○																													
130	○	V4	○	○	○	○	○	○	U4	R4	○	○	○	○	○	○	○	F4	○	○	○	○	○	○	○	○	○	○																													
125	○	○	○	○	○	○	○	○	U3	R3	○	KG3	XG3	K3	X3	○	○	○	○	P125	Q125	SD125	TD125	PD125	QD125	HS125	HP125	HN125																													
123	○	○	○	○	○	○	○	○	○	○	○	○	○	○	○	○	○	○	○	○	○	○	○	○	○	○	○	○																													
120	○	○	○	○	○	○	○	○	○	○	○	○	○	○	○	○	○	○	○	○	○	○	○	○	○	○	○	○																													
115	○	V2	○	○	C2	○	○	○	U2	R2	○	KG2	XG2	K2	X2	F2	○	○	P115	Q115	SD115	TD115	PD115	QD115	○	○	○	○																													
105	○	○	○	○	○	○	○	○	○	○	○	○	○	○	○	○	○	○	○	○	○	○	○	○	○	○	○	○																													
102	○	○	○	○	○	○	○	○	U1	R1	○	KG1	XG1	K1	X1	F1	○	○	P102	Q102	SD102	TD102	PD102	QD102	○	○	○	○																													
97	○	○	○	○	○	○	○	○	○	○	○	○	○	○	○	○	○	○	○	○	○	○	○	○	○	○	○	○																													
95	○	○	○	○	○	○	○	○	○	○	○	○	○	○	○	○	○	○	○	○	○	○	○	○	○	○	○	○																													
86	○	○	○	C18	○	○	○	○	U18	R18	○	KG18	XG18	K18	X18	F18	○	○	○	○	○	○	○	○	○	○	○	○																													
76	○	○	○	○	○	○	○	○	U0	R0	○	○	○	○	○	○	○	○	○	○	○	○	○	○	○	○	○	○																													
额定电流 Rated Current $I_F$ (A)	5					4			5			6		8		8.5		9		10		10		15		15		2		3		2		3		3		4		20		25		10		15 16		20		25		5		10		15	
额定电压 Rated Voltage $U_F$ (VDC)	60										120										125					200																															
产品结构 Product Structure																																																									
	轴向型 Axial Shape															径向型 (带螺丝孔) Radial Shape (Screw Hole)										径向型 Radial Shape					轴向型 (扁电极) Axial Shape (Flat Electrode)																										

备注 Note:

\*: 表示产品还在开发中。Indicates that the product is under development.

# 温度保险丝

Thermal-Link (ATCO)

## 工作原理 Operation Principle

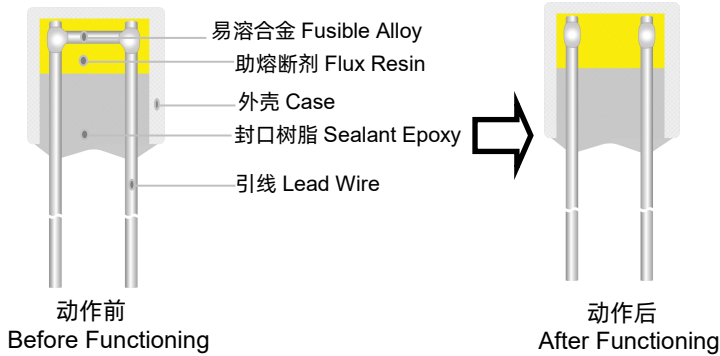

熔断图 (仅供参考)  
Fusing Diagram (For reference only)

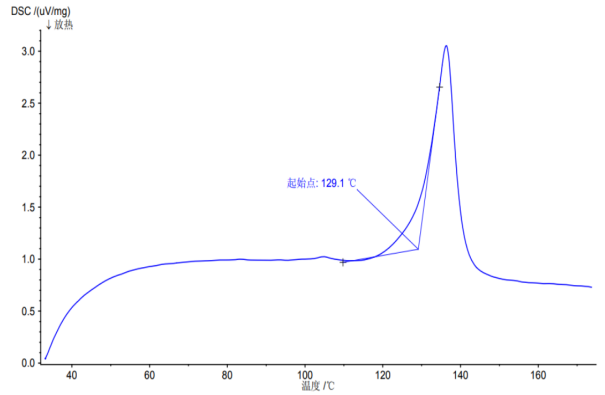

易熔合金熔点测试图  
Diagram of melting point test for Fusible Alloy

在正常工作情况下，易熔合金与两根引线保持连接，当合金型温度保险丝（引脚及外壳）感受到异常发热并达到预定的熔断温度时，易熔合金熔化，并在助熔断剂的作用下快速收缩至引线两端，从而断开电路。  
Under abnormal conditions, when the Temp. reaches to the fusing Temp. of ATCO, the Fusible Alloy melts and quickly retracts to the two Lead Wire ends with the aid of the Flux Resin and disconnects the circuit completely.

## 应用案例 Application Example

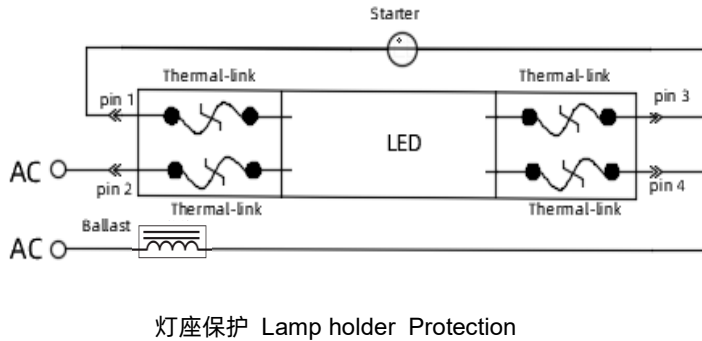

灯座保护 Lamp holder Protection

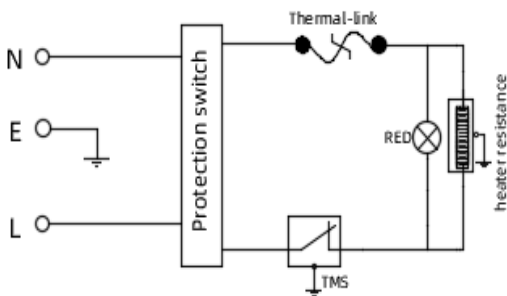

电热器具的热保护 Electrical Heating Devices Protection

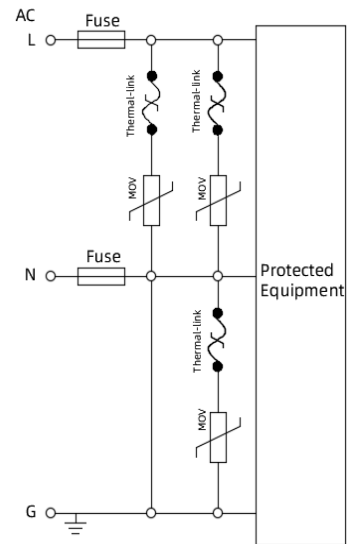

防雷插座防浪涌保护 Surge Protection

# 温度保险丝

Thermal-Link (ATCO)

## 产品描述 Description

合金型温度保险丝是一次性动作而不可复位的装置。它广泛应用于电气设备的过温保护。其主要由低熔点的易熔合金、助熔断剂、外壳、封口树脂和引线组成。在正常工作情况下，易熔合金与两根引线保持连接，当合金型温度保险丝感受到异常发热并达到预定的熔断温度时，易熔合金熔化，并在助熔断剂的作用下快速收缩至引线两端，从而断开电路。赛尔特公司的合金型温度保险丝结构分为轴向型和径向型，额定动作温度：(76 ~ 230) °C、额定电流：(1 ~ 200) A，安规认证包括：CCC, UL, cUL, VDE, TUV, KC, PSE, 同时满足RoHS、REACH 等环保要求。

Alloy Thermal-Link / Alloy Thermal Cutoff (ATCO) is defined as a non-resettable protective device functioning one time only. It is widely used in electrical equipment. ATCO is mainly consist of Fusible Alloy, Flux Resin, Case, Sealant and Lead Wires. Normally, Fusible Alloy is jointed to the two Lead Wires. Under abnormal conditions, when the Temp. reaches to the fusing Temp. of ATCO, the Fusible Alloy melts and quickly retracts to the two Lead Wire ends with the aid of the Flux Resin and disconnects the circuit completely. SETsafe | SETfuse ATCO is classified into Axial and Radial shapes, with Rated Current 1 A to 200 A, Rated Functioning Temp. 76 °C to 230 °C, with CCC, UL, cUL, VDE, TUV, KC, PSE, Approvals and RoHS, REACH compliant.

## 应用 Applications

- |        |                             |
|--------|-----------------------------|
| ● 照明   | Lighting                    |
| ● 电源   | Power Supply                |
| ● 家用电器 | Home Electrical Appliances  |
| ● 防雷插座 | Power Strips                |
| ● 电热器具 | Electric Heating Appliances |
| ● 通信   | Telecom                     |
| ● 电池   | Batteries                   |

## 结构图 Structure

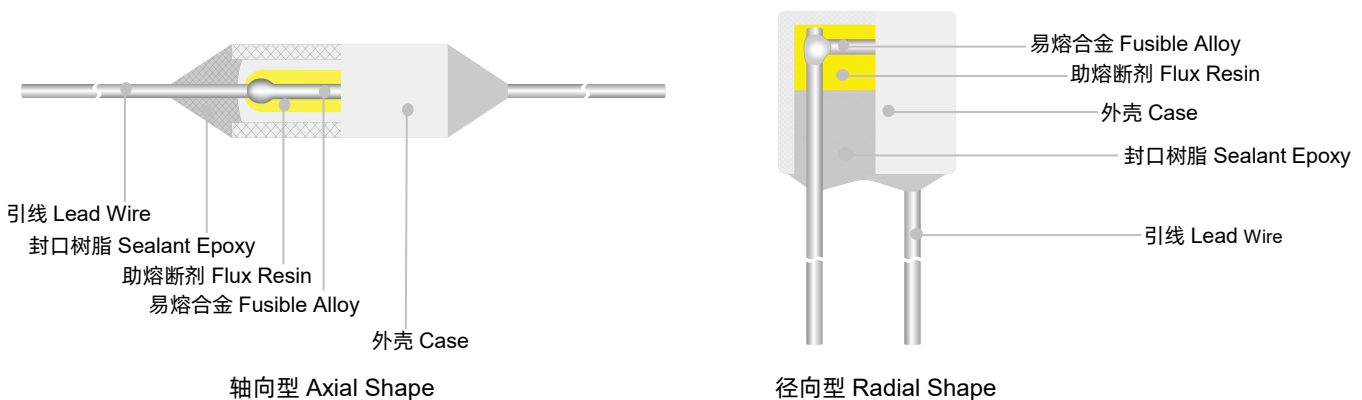



# 温度保险丝

Thermal-Link (ATCO)

## 型号说明 Part Number System

ATCO - T 115 - A N N A B - 001

ATCO

ATCO

流水号 Serial Number

包装 Packing

B 散装 Bulk

T 编带 Taping

引脚成型 Leads Forming

A 直引脚 Straight Lead

B 单脚折弯 Single Lead Bending

C 双脚折弯 Leads Bending

D 引脚打印子 Leads Kinking

E 引脚折弯和打印子 Leads Bending

绝缘层颜色 Color of Insulation Tube

W 白色 White

Y 黄色 Yellow

R 红色 Red

K 黑色 Black

N 无 None

绝缘层材质 Insulation Tube Material

T 铁氟龙 Teflon

P 聚酯 Polyester

N 无 None

引线类型 Lead Wire Type

A 镀锡铜线 Tinned Copper Wire

B 镀锡铜包钢线 Tinned Copper Clad Steel Wire

额定动作温度 Rated Functioning Temp.

115 115 °C, 请参考技术参数表 Refer to specifications

系列 Series

T 系列, Series

请参考技术参数表 Refer to specifications

产品类别 Product Category

ATCO 温度保险丝 Thermal-Link

# 温度保险丝

Thermal-Link (ATCO)

## 术语 Glossary

项目 Item	描述 Description
TCO	<p><b>温度保险丝 Thermal-Link</b> 一种装有热元件的不可复位的器件，当它被暴露在超过所设计的温度下达到一个足够长的时间时会将电路断开。 — (GB 9816.1)</p> <p>A non-resettable device incorporating a THERMAL ELEMENT which will open a circuit once only when exposed for a sufficient length of time to a temperature in excess of that for which it has been designed. — (IEC 60691)</p>
ATCO	<p><b>合金型温度保险丝 Alloy Thermal-Link</b> 合金型温度保险丝，由易熔合金作为感温部件的热熔断体。 — (GB/T 9816.3)</p> <p>Alloy Type Thermal-Link, Alloy is the thermal element.</p>
$T_f$	<p><b>额定动作温度 Rated Functioning Temp.</b> 在仅通以不超过10 mA的探测电流的条件下，测得的使热熔断体导电状态改变的温度。 — (GB 9816.1)</p> <p>The temperature of the Alloy Thermal-Link which causes it to change the state of conductivity with a detection current up to 10 mA as the only load. — (IEC 60691)</p> <p>允许偏差 Tolerance: <math>T_f + 0 / - 10</math> °C (GB 9816.1, EN 60691, K60691).</p> <p>允许偏差 Tolerance: <math>T_f \pm 7</math> °C (J60691).</p>
Fusing Temp.	<p><b>实测熔断温度 Fusing Temp.</b> 置于油池中，通10 mA以下的负载电流，每分钟升温0.5 °C ~ 1 °C，测断开温度。 — (GB 9816.1)</p> <p>The temperature of the Alloy Thermal-Link which causes it to change its state of conductivity is measured with silicone oil bath in which the temperature is increased at the rate of 0.5 °C to 1 °C / minute, with a detection current up to 10 mA as the only load. — (IEC 60691)</p>
$T_h$	<p><b>保持温度 Holding Temp.</b> 热熔断体在规定的条件下，规定时间内不改变其导通状态的最高温度。 — (GB 9816.1)</p> <p>The maximum temperature at which a Alloy Thermal-Link will not change its state of conductivity when conducting rated current for 168 hours. — (IEC 60691)</p>
$T_m$	<p><b>最高极限温度 Maximum Temp. Limit</b> 由制造厂规定的温度。在此温度下，热熔断体导电状态已改变，但其机械性能和电气性能在规定时间内不至于减弱。 — (GB 9816.1)</p> <p>The temperature of the Alloy Thermal-Link stated by the manufacturer, up to which the mechanical and electrical properties of the Alloy Thermal-Link having changed its state of conductivity, will not be impaired for a given time. — (IEC 60691)</p>
$I_r$	<p><b>额定电流 Rated Current</b> 温度保险丝分类用，允许用于电路并安全断开的最大电流。 — (GB 9816.1)</p> <p>The current used to classify a Alloy Thermal-Link, which is the maximum current that Alloy Thermal-Link allows to carry and is able to cut off the circuit safely. — (IEC 60691)</p>
$U_r$	<p><b>额定电压 Rated Voltage</b> 温度保险丝分类用，允许用于电路并安全断开的最高电压。 — (GB 9816.1)</p> <p>The voltage used to classify a Alloy Thermal-Link, which is the maximum voltage that Alloy Thermal-Link allows to carry and is able to cut off the circuit safely. — (IEC 60691)</p>
$I_n$	<p><b>标称放电电流 Nominal Discharge Current</b> 能够承受15次波形为8/20μs的电流峰值，用于检测产品所能承受脉冲电流耐久性的能力。 — (UL 1449)</p> <p>Being able to withstand 15 peak currents of waveform 8 / 20 μs to test the product's durability of withstanding pulse current.</p>
$I_{max}$	<p><b>最大放电电流 Maximum Discharge Current</b> 能够承受1次波形为8/20μs的电流峰值，用于检测产品所能承受的最大脉冲电流。 — (UL 1449)</p> <p>Being able to withstand 1 peak current of waveform 8 / 20 μs to test maximum pulse current that the product can withstand.</p>

ATCO

ATCO



# 温度保险丝

## Thermal-Link (ATCO)

### 焊接 Soldering

#### 手工焊接 Hand-Soldering

1. 焊接必须在表T-1所列的条件下进行。  
Soldering should be carried out according to Table T-1.
2. 由于温度保险丝中与引线连接的感温体是低熔点的合金，因此不正确的焊接操作（例如：温度过高、焊接时间过长、引线过短等）可能导致感温体被引线传递的过高热量所影响，从而使得温度保险丝提前断开。  
The thermal element of ATCO is fusible alloy with low melting point, which is jointed with ATCO Lead Wires. Improper soldering operation (too high soldering Temp., too long soldering time, too short lead wire etc.) may transfer more heat to the thermal element and ATCO may open in advance.
3. 若需要在表T-1规定更为严苛环境下进行焊接时，应在焊接点和温度保险丝主体间的引线上使用散热装置。  
When soldering conditions are more severe than those listed in Table T-1, a heat sink fixture should be used between soldering point and ATCO body.
4. 焊接时应小心，以避免温度保险丝主体和引线遭受到推 / 拉力以及扭力。  
When soldering, please do not pull / push or twist ATCO body or lead wires.
5. 焊接后应让其自然冷却20s以上，在冷却期间，勿移动温度保险丝本体和引线。  
After soldering, let it naturally cool for more than 20 seconds. During cooling, do not move the ATCO body or Lead Wires.

#### 波峰焊接 Wave Soldering

波峰焊参数如表T-2，仅供参考，实际使用时应做相关的试验进行验证，如在波峰焊后通过X-ray观察来判断温度保险丝的感温合金是否受损。

The wave soldering parameters as Table T-2, for reference only, when ATCO is for practice use, you need to do some validation experiments. For example, using X-RAY to see the fusible alloy of ATCO whether damage after wave soldering.

表 T-1: 手工焊接时间 TABLE T-1 Hand-Soldering Time

额定动作温度 Rated Functioning Temp. (T <sub>f</sub> )	不同引线长度对应的最大允许焊接时间 Max. Allowable Soldering Time for Different Lead Wire Length (Fig.T-1)									最高焊接 温度 Max. Soldering Temp.
	L <sub>s</sub> 长度 Length	时间 Time		L <sub>s</sub> 长度 Length	时间 Time		L <sub>s</sub> 长度 Length	时间 Time		
		镀锡铜线 Tinned Copper Wire	CP线 CP Wire		镀锡铜线 Tinned Copper Wire	CP线 CP Wire		镀锡铜线 Tinned Copper Wire	CP线 CP Wire	
(°C)	(mm)	(s)	(s)	(mm)	(s)	(s)	(mm)	(s)	(s)	(°C)
76 ~ 101	10	1 <sup>a</sup>	4	20	2	5	30	3	6	400
102 ~ 115	10	1 <sup>a</sup>	4	20	2	5	30	3	6	
116 ~ 135	10	1 <sup>a</sup>	4	20	3	6	30	5	8	
136 ~ 150	10	3	6	20	5	8	30	5	8	
151 ~ 230	10	4	7	20	6	9	30	7	10	

a: 为防止温度保险丝被焊断，焊接时视需要增加辅助散热装置。 Auxiliary heat sink fixture is required to avoid ATCO cutting off unexpectedly.



图 FIGURE T-1

# 温度保险丝

Thermal-Link (ATCO)

表T-2 波峰焊参数设置 TABLE T-2 Wave Soldering Parameters Setting

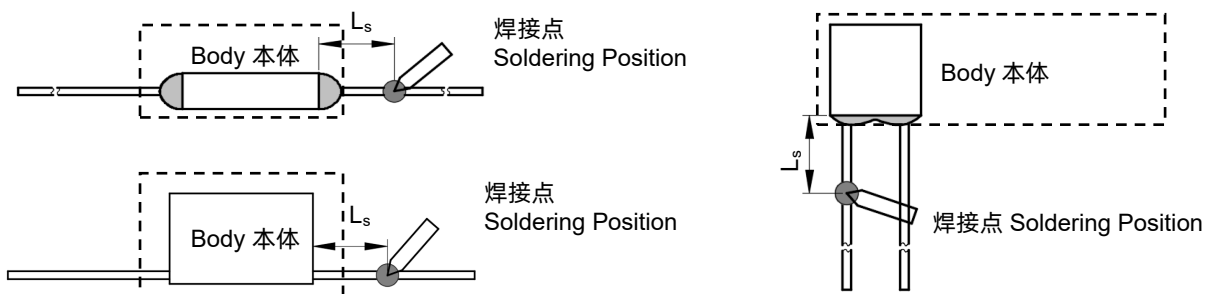
额定动作温度 Rated Functioning Temp. ( $T_f$ )	不同引线长度对应的最大允许焊接时间 Max. Allowable Preheating Temp. When the Length of Lead Wire is Different(Fig.T-1)				预热时间 Preheating Time ( $t_1$ )	最大波峰 温度 Max. Wave Soldering Temp.	过锡时间 Dwelling Time ( $t_2$ )	冷却时间 Cooling Time ( $t_3$ )
	$L_s$ 长度 Length	预热温度 Preheating Temp.	$L_s$ 长度 Length	预热温度 Preheating Temp.				
(°C)	(mm)	(°C)	(mm)	(°C)	(s)	(°C)	(s)	(s)
76 ~ 130	建议手工焊接 Recommend Hand-Soldering							
131 ~ 150	20	80	30	90	< 60	≤ 260	≤ 3	≤ 10
151 ~ 230	20	90	30	100	< 60	≤ 260	≤ 3	≤ 10

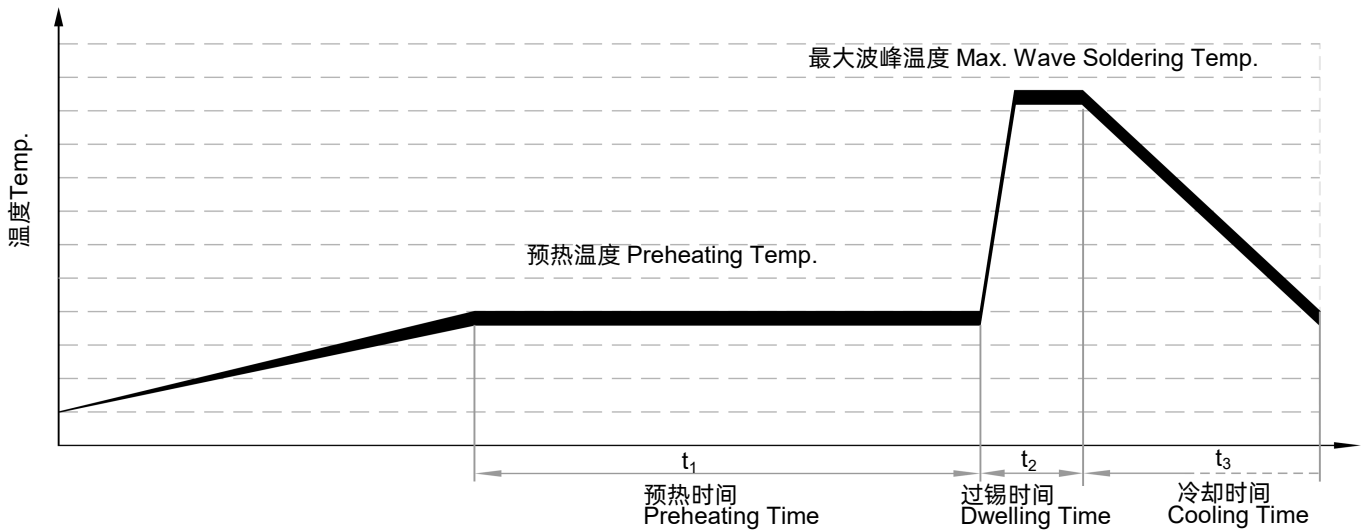

## 引线成型 Lead Wire Forming

- 如果一定要弯折引线，那么应确保弯折处与主体间的距离，如表 T-3、表T-4。  
If lead wire has to be bent, please pay attention to the distance between body and bending point. Refer to Table T-3,T-4.
- 弯折引线时请使用钳子或其它工具固定（如图T-2、T-3所示），以免损坏产品。  
When bending leads, please use pincher or similar tools to fix the product as shown in Fig.T-2,T-3, to avoid damaging the product.
- 成形和安装过程中，对引线进行裁切、切割、弯折时，请勿用力过猛，以免造成产品断裂或本体损伤。  
During forming and mounting, lead wire should not be cut, nicked, bent sharply, to avoid breaking the product.
- 避免直接对引线根部施加外力（比如与温度保险丝主体成一定角度推或拉），以免损坏温度保险丝封口。  
Tangential forces on the leads must be avoided (i.e. pushing or pulling on the leads at angle to ATCO body) as such forces may damage the seal of ATCO.



图 FIGURE T-2

# 温度保险丝

Thermal-Link (ATCO)

表T-3 本体与折弯处之间的距离  
TABLE T-3 Distance between Body and Bending Point

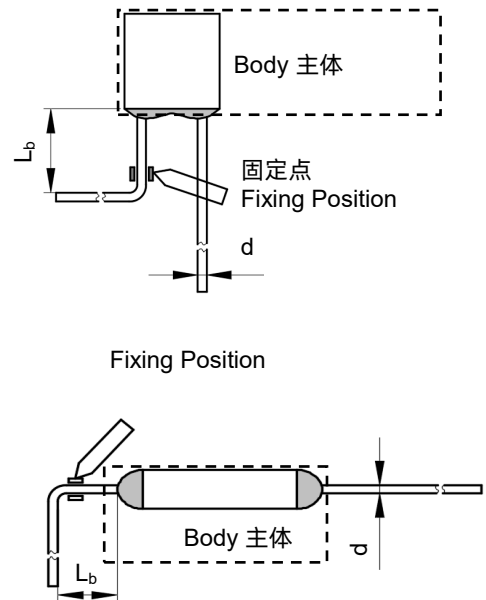
圆形引线 Round Lead Wire	d	(mm)	< 1.0	1.0 - 1.2	> 1.2
	L <sub>b</sub>	(mm)	≥ 3	≥ 5	≥ 10



图 FIGURE T-3

表T-4 本体与折弯处之间的距离  
TABLE T-4 Distance between Body and Bending Point

扁电极 Flat Electrode Chamber	T <sub>1</sub>	(mm)	< 0.25	0.25 - 0.5	> 0.5
	L <sub>b</sub>	(mm)	≥ 3	≥ 5	≥ 10

# 温度保险丝

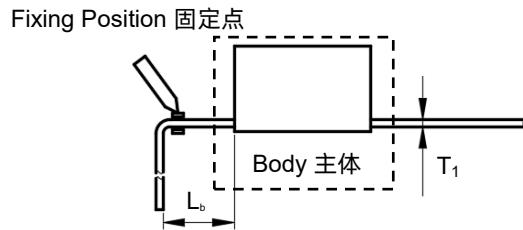
Thermal-Link (ATCO)



## 注意 ATTENTION

### 使用 Usage

1. 气压: 80 kPa 到106 kPa, 对应海拔: +2000 m 到- 500 m。  
When atmosphere pressure is from 80 kPa to 106 kPa, the related altitude shall be from 2000 meter to - 500 meter.
2. 工作电压不超过温度保险丝的额定电压; 工作电流不超过额定电流。  
Operating voltage should be less than rated voltage of ATCO, operating current should be less than rated current of ATCO.
3. 通电情况下请勿用人体直接接触本体或引脚, 防止烫伤或触电。  
Do not touch the ATCO body or lead wires directly when power is on, to avoid burning or electric shock.

### 更换 Replacement

温度保险丝是不可修复的产品。基于安全原因, 替换时应使用同类别、同型号的温度保险丝并且严格按照同样的方法正确安装。  
ATCO is a non-repairable product. For safety sake, it shall be replaced by an equivalent ATCO from the same manufacturer, and mounted in the same way.

### 贮存 Storage

温度保险丝的贮存应避免高温、高湿、日光直射和腐蚀性气体的场合, 避免影响引线可焊性, 产品购入后请于1年内使用完毕。  
Do not store the ATCO at the high Temp., high humidity or corrosive gas environment, avoid influencing the solder-ability of the lead wires, the product shall be used up within 1 year after receiving the goods.

# 温度保险丝

Thermal-Link (ATCO)

## 安装 Installation

### 安装位置的温度确定 Make Sure the Temp. of Installation Position.

1. 建议采用内置热电偶式的仿真温度保险丝来确定适合的温度要求。  
It is recommended that a dummy ATCO with inbuilt thermo-couple shall be used to determine the proper Temp.
2. 需对终端产品进行测试，以确保潜在的异常状况不会导致温度保险丝超过其极限温度。  
The terminal product should be tested to ensure that potential abnormal conditions do not cause ambient Temp. to exceed the  $T_m$  of the ATCO.
3. 将温度保险丝安装在可使其温度平稳上升的部位。  
Mount the ATCO at the location where Temp. rises evenly.
4. 温度保险丝本体表面的温度不超过温度保险丝的保持温度。  
The surface Temp. of ATCO less than the holding temp of ATCO.
5. 保险丝的封口及主体不能烧伤或者过度受热。  
The seal or body of TCO must not be burned or over heated.

### 安装位置的机械性能要求 Installation position of mechanical performance requirements.

1. 勿将温度保险丝安装在可能经常出现剧烈振动的地方。  
Do not locate the ATCO in a place where severe vibration always occurs.
2. 确保引线足够长，且其安装方法不会造成强行按压、拉伸及扭转引线之现象。  
Ensure that the lead wire is long enough, and avoid actions such as press, tensile or twist.
3. 温度保险丝的封口及主体不能受损。  
The seal or body of ATCO must not be damaged.

## 机械连接 Mechanical Connection

### 铆接 Riveting

1. 选用电阻率小的铆接材料和被铆接材料。  
Choose small resistivity riveting material and be riveted.
2. 采用柔韧的、易弯曲的引线来与温度保险丝铆接。  
A flexible lead or lead with low resistance should be used to rivet the ATCO.
3. 应确保铆接后的接触电阻为最小值，过大的接触电阻会产生较高的温升，造成温度保险丝提前熔断。  
Contact resistance should be minimal, large contact resistance will lead to higher Temp., ATCO Functioning in advance.

### 压接 Crimping

1. 选用电阻率小的压接材料和被压接材料。  
Choose small resistivity crimping material and be riveted.
2. 压接过程中，确保引线不会被扭转、封口树脂不会被破坏。  
Crimping process, to ensure that the lead will not be reversed, sealing resin will not be destroyed.
3. 应确保压接后的接触电阻为最小值，过大的接触电阻会产生较高的温升，造成温度保险丝提前熔断。  
Contact resistance should be minimal, large contact resistance will lead to higher Temp. rising, ATCO Functioning in advance.

# 温度保险丝

Thermal-Link (ATCO)

V系列 Series

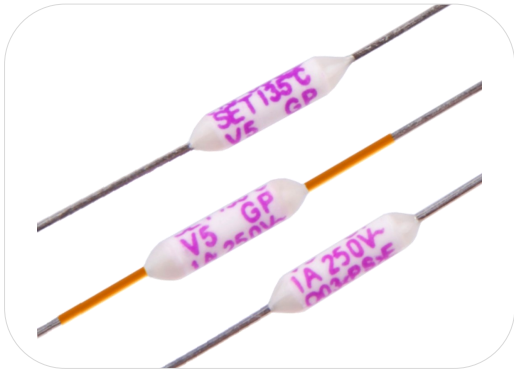

## 应用 Applications

- 灯具 Lamps
- 开关电源 Switched-Mode Power Supplies
- 家用电器 Home Electrical Appliances
- 变压器 Transformers
- 电机 Motors
- 电热毯 Electric Blankets
- 香薰器 Electric Aroma Diffusers

## 特性 Features

- 动作温度精确 High Accuracy of Functioning Temp.
- 一次性动作而不可复位 Non-Resettable
- 环保型产品 RoHS & REACH Compliant

## 定制 Customization

- 温度 Temp.
- 引线长度 The Length of Lead Wires
- 可编带包装 Taping Packing Available
- 引线可采用绝缘线 Lead Wires can be Insulated
- 引线材质可选镀锡铜线或CP线 Tinned Copper Wires or CP Wires

## 安规认证 Agency Approvals

安规 Agency Mark	标准 Standards	认证号 No.
	UL 60691	E214712
	CAN-CSA-E60691	E214712
	EN 60691	R50112716
	J60691	PSE15020870、PSE15020871 PSE15020872、PSE15020873 PSE15020874
	K60691	SU05023-11001、SU05023-11002 SU05023-11003
	GB 9816.1	2020980205000183

## 尺寸 Dimensions (mm)

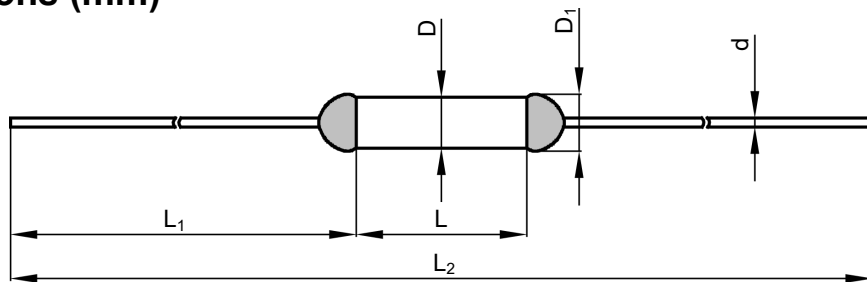

L	L <sub>1</sub>	L <sub>2</sub>	D	D <sub>1</sub>	d
6.5 ± 0.5	36.0 ± 2.0	78.5 ± 3.0	2.1 ± 0.5	≤ 2.6	0.50 ± 0.05



# 温度保险丝

Thermal-Link (ATCO)

V系列 V Series

## 技术参数 Specifications

型号 Model	额定动作 温度 $T_f$	熔断温度 Fusing Temp.	保持温度 $T_h$	极限温度 $T_m$	额定电流 $I_r$	额定电压 $U_r$	UL <sup>®</sup>	cUL <sup>®</sup>	TUV <sup>®</sup>	PSE <sup>®</sup>	KTL <sup>®</sup>	CCC <sup>®</sup>	RoHS REACH			
	(°C)	(°C)	(°C)	(°C)	(A)	(V)	UL	cUL	TUV	PSE	KTL	CCC				
V0	76	73 ± 2	53	200	1	AC 250	○	○	●	●	●	●	●			
						AC 125	●	●	○	○	○	○	○	○	●	
						DC 50	●	●	○	○	○	○	○	○	●	
V18	86	81 ± 2	61	200	1	AC 250	○	○	●	●	●	●	●			
						AC 125	●	●	○	○	○	○	○	○	●	
			DC 50	●	●	○	○	○	○	○	○	○	●			
			55	2.5	DC 60	●	●	●	○	○	○	○	○	●		
V21	97	93 ± 2	70	200	1	AC 250	○	○	○	○	○	○	○	●		
						AC 125	●	●	○	○	○	○	○	○	○	●
						DC 50	●	●	○	○	○	○	○	○	○	●
V1	102	98 ± 3	79	200	1	AC 250	○	○	●	●	●	●	●			
						AC 125	●	●	○	○	○	○	○	○	○	●
						DC 50	●	●	○	○	○	○	○	○	○	●
V2	115	111 ± 2	91	200	1	AC 250	●	●	●	●	●	●	●			
			80			4	DC 60	●	●	●	○	○	○	○	○	●
V3	125	121 ± 2	100	200	1	AC 250	●	●	●	●	●	●	●			
						DC 50	●	●	○	○	○	○	○	○	○	●
V4	130	125 ± 2	106	200	1	AC 250	●	●	●	●	●	●	●			
			DC 50			●	●	○	○	○	○	○	○	○	●	
			100	4	DC 60	●	●	●	○	○	○	○	○	●		
V8	133	130 ± 2	111	200	1	AC 250	●	●	●	●	●	●	●			
			DC 50			●	●	○	○	○	○	○	○	○	●	
			80	4	DC 60	●	●	●	○	○	○	○	○	●		
V5	135	130 ± 2	111	200	1	AC 250	●	●	●	●	●	●	●			
						DC 50	●	●	○	○	○	○	○	○	○	●
V9	136	131 ± 2	112	200	1	AC 250	●	●	●	●	●	●	●			
						DC 50	●	●	○	○	○	○	○	○	○	●
V13	139	135 ± 2	115	200	1	AC 250	●	●	●	●	●	●	●			
			DC 50			●	●	○	○	○	○	○	○	○	●	
			90	4	DC 60	●	●	●	○	○	○	○	○	●		
V6	145	140 ± 2	121	200	1	AC 250	●	●	●	●	●	●	●			
						DC 50	●	●	○	○	○	○	○	○	○	●
V7	150	145 ± 2	126	200	1	AC 250	●	●	●	●	●	●	●			
						DC 50	●	●	○	○	○	○	○	○	○	●

备注 Note:

"●"表示产品已通过认证。Means certificated.

"○"表示产品未有认证。Means non-certificated.

产品温度时间曲线图 (仅供参考)  
Product Temp.-Time Curve (For Reference Only)

温度保险丝在不同温度油浴中断开的温度时间曲线。  
The Temp.-Time Curve of Thermal-Link in different Temp. oil baths.

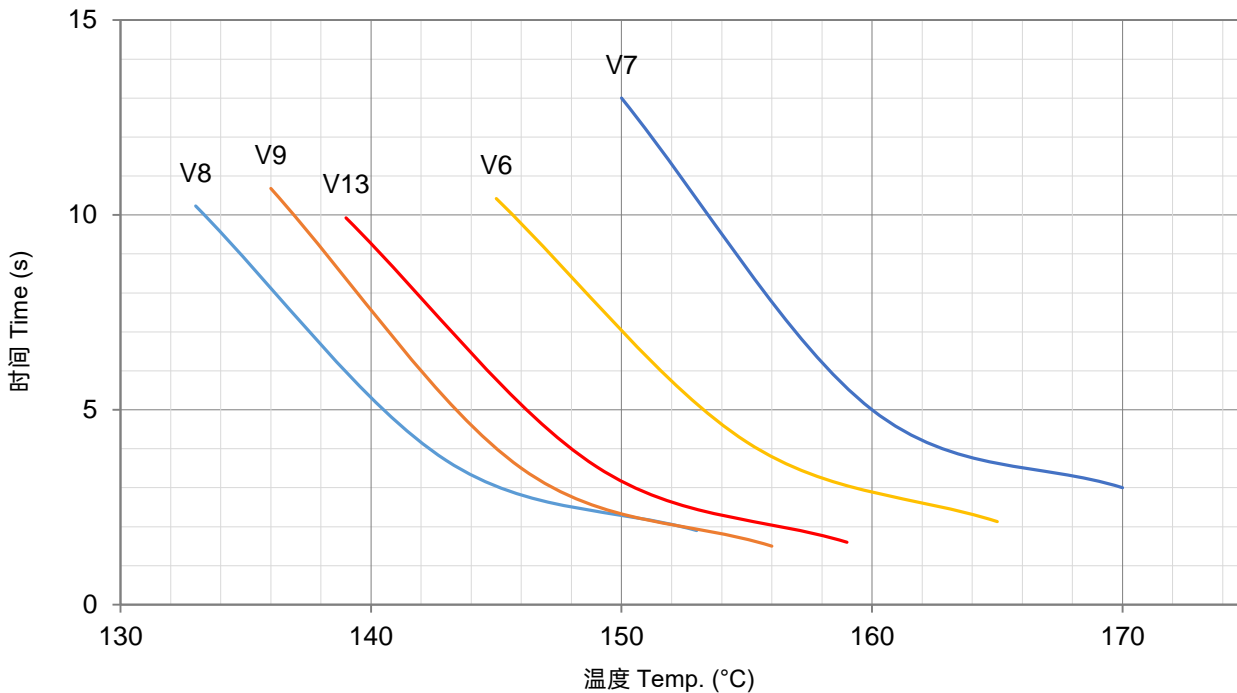
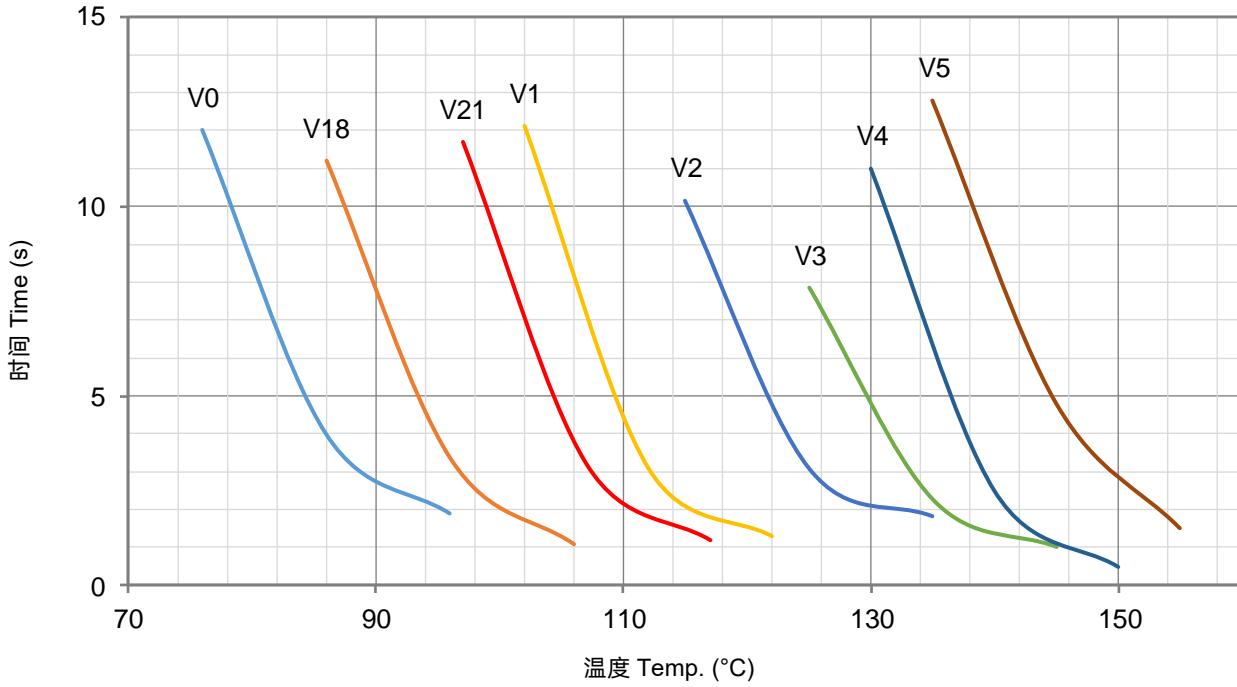

产品电流时间曲线图 (仅供参考)  
Product Current-Time Curve (For Reference Only)

温度保险丝在室温 $25 \pm 2 \text{ }^\circ\text{C}$ 条件下, 测试数倍过载电流下的断开时间曲线。  
The Current-Time Curve shows functioning time at multi-times rated current at room temperature  $25 \pm 2 \text{ }^\circ\text{C}$ .

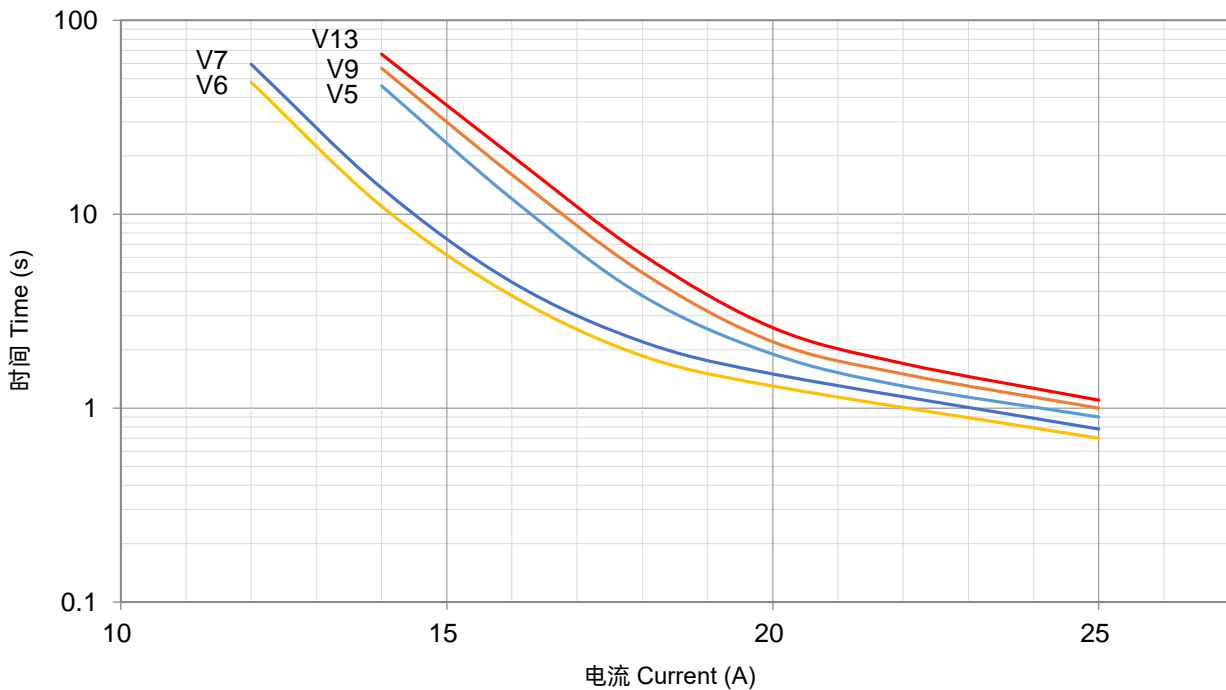
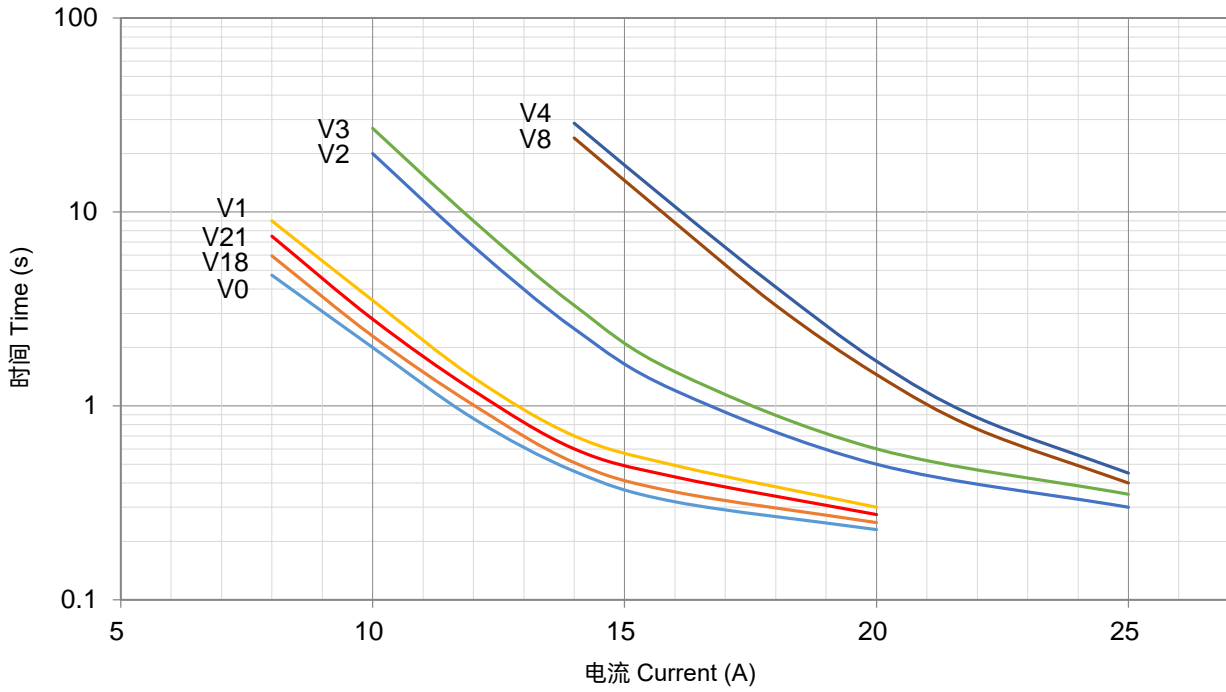

包装信息 Packaging Information

散装 Bulk

项目 Item	PE 袋 Bag	PE 袋 Bag	包装箱 Carton
尺寸 Dimensions (mm)	135 × 85	190 × 180	440 × 300 × 260
数量 Quantity (PCS)	100	1000	50000
毛重 Gross Weight (kg)			11.5 ± 10%

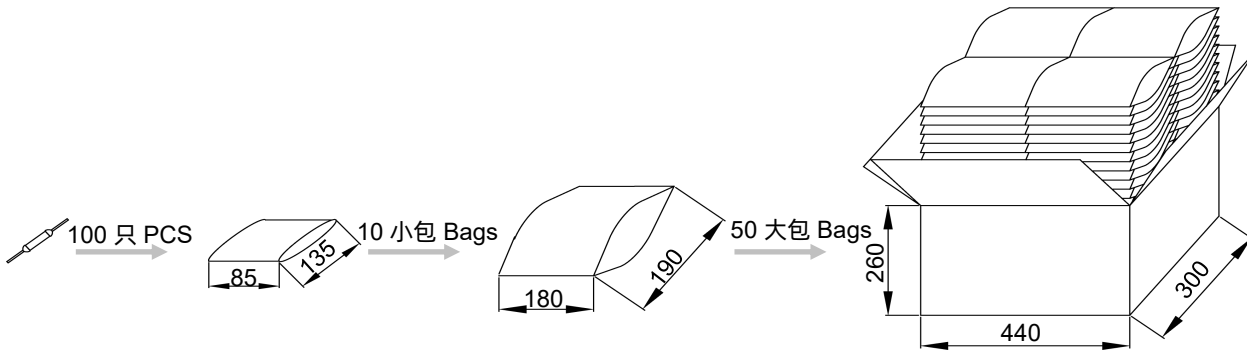

编带 Taping

项目 Item	卷轴 Scroll	盒子 Box	包装箱 Carton
尺寸 Dimensions (mm)	Φ 250 × 94	258 × 258 × 98	480 × 300 × 260
数量 Quantity (PCS)	2500	2500	10000
毛重 Gross Weight (kg)			4.2 ± 10%

